

FEATURES

- 88-126VAC Single-Phase Input Voltage
- Rated Torque of 0.64 Nm
- Power Ratings up to 200 Watts
- 2,500 PPR Incremental Encoder
- Maximum Speed of 3000 RPM
- IP65 for Body, IP54 Shaft Seal
- Brake Option Available
- Position, Speed, and Torque Control
- RS232 and RS485 Port



DESCRIPTION

The PKS-FD322S-02-60S-AAK-AKH Servo System includes a 200 Watt SMH60S-0020 AC Servo Motor operated by the FD322S-LA-000 Drive. These packages are ideal and easy start-ups, convenience, and performance. The Servo Motors included in these packages provide torque up to 0.64 Nm. The FD322S-LA-000 Drive offers current forward-feedback control, acceleration forward-feedback control, speed viewer, and inertia viewer; providing for improved response performance. Each system includes a 5m Motor Power Cable and a 5m Encoder Cable. If purchasing the option with a Brake then a 5m Brake Cable will be included.

| Item                      | Rated Voltage (VAC) | Rated Speed (RPM) | Rated Torque (NM) | Rated Current (Arms) | Inertia (oz-in-sec <sup>2</sup> ) | Torque Constant KT (oz-in/A) | Resistance (ohms) | Inductance (mH) | Brake (24VDC) | Motor Length (mm) | Shaft Diameter (mm) |
|---------------------------|---------------------|-------------------|-------------------|----------------------|-----------------------------------|------------------------------|-------------------|-----------------|---------------|-------------------|---------------------|
| PKS-FD322S-02-60S-AAK-AKH | 88-126              | 3000              | 0.64              | 2.7                  | 0.00365                           | 33.98                        | 2.1               | 4.1             | No            | 120               | 14                  |
| PKS-FD322S-02-60S-ABK-AKH | 88-126              | 3000              | 0.64              | 2.7                  | 0.00365                           | 33.98                        | 2.1               | 4.1             | Yes           | 159               | 14                  |

ORDERING INFORMATION

## PKS-FD322S-02-60S-AAK-AKH

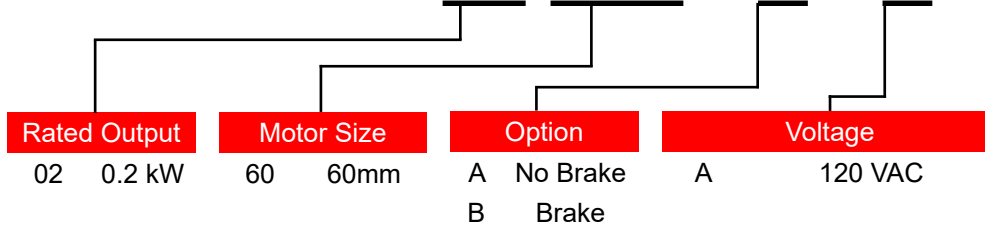

L011568

# SMH60S-0020 Motor Specifications



## FEATURES

- 220 VAC
- 200 W Power Rating
- Rated Torque of 91 oz-in
- Maximum Speed of 3000 rpm
- 2500 PPR Incremental Encoder Attached
- IP65 for Body, IP54 Shaft Seal
- Brake Option Available
- CE Certified



## SPECIFICATIONS

| Item                   | Rated Torque (NM) | Rated Power (Watts) | Rated Speed (rpm) | Rated Current (Arms) | Inertia (oz-in-sec <sup>2</sup> ) | Torque Constant KT (oz-in/A) | Resistance (ohms) | Inductance (mH) | Length (mm) | Weight (lbs) |
|------------------------|-------------------|---------------------|-------------------|----------------------|-----------------------------------|------------------------------|-------------------|-----------------|-------------|--------------|
| SMH60S-0020-30AAK-3AKH | 91                | 200                 | 3000              | 2.7                  | 0.00531                           | 33.98                        | 2.1               | 4.1             | 120         | 2.86         |
| SMH60S-0020-30ABK-3AKH | 91                | 200                 | 3000              | 2.7                  | 0.00531                           | 33.98                        | 2.1               | 4.1             | 159         | 3.96         |

## DIMENSIONS

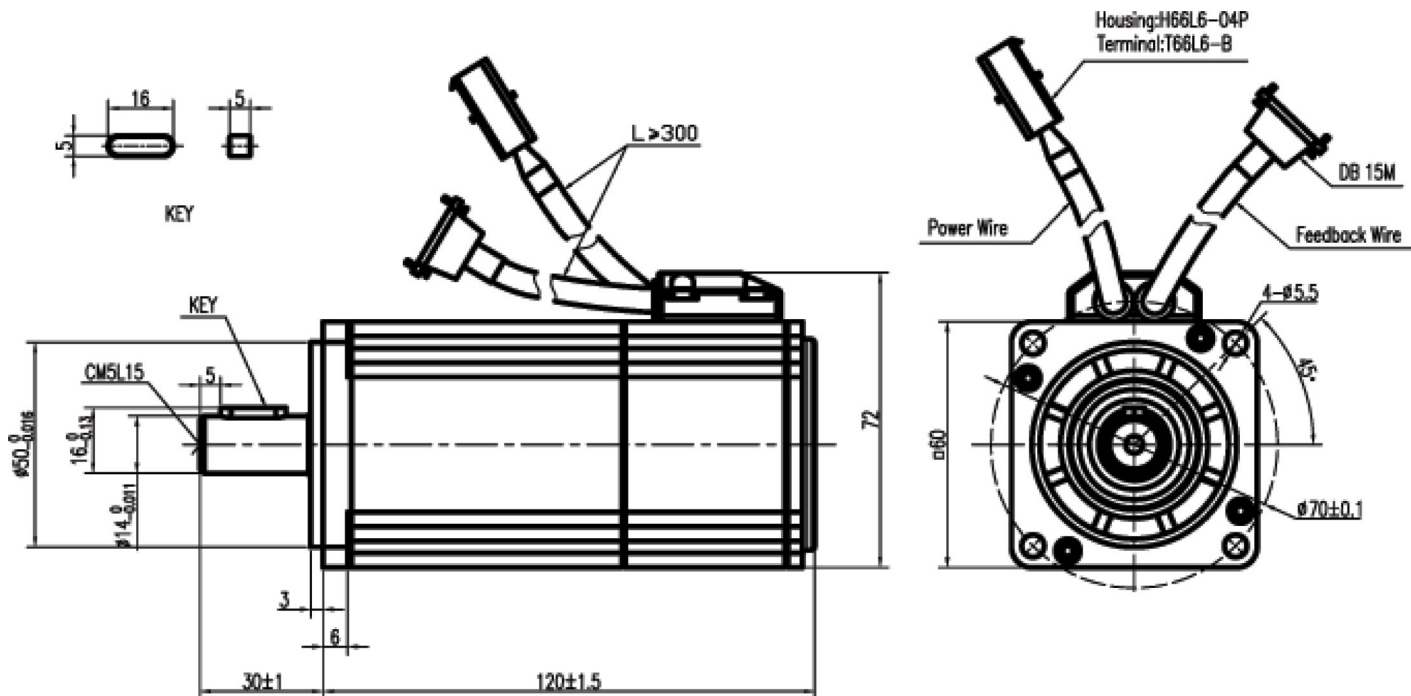

Note: Part Number SMH60S-0020-30ABK is with the brake option. Brake option not shown in above dimensions.

Dimensions are in mm

# FD322S-LA-000 Driver Specifications



## FEATURES

- Input Voltage Range of 88-126VAC
- 200 W Power Rating
- Rated Torque of 91 oz-in
- Maximum Speed of 3000 rpm
- 2500 PPR Incremental Encoder Attached
- IP65 for Body, IP54 Shaft Seal
- Brake Option Available
- CE Certified



## DIMENSIONS

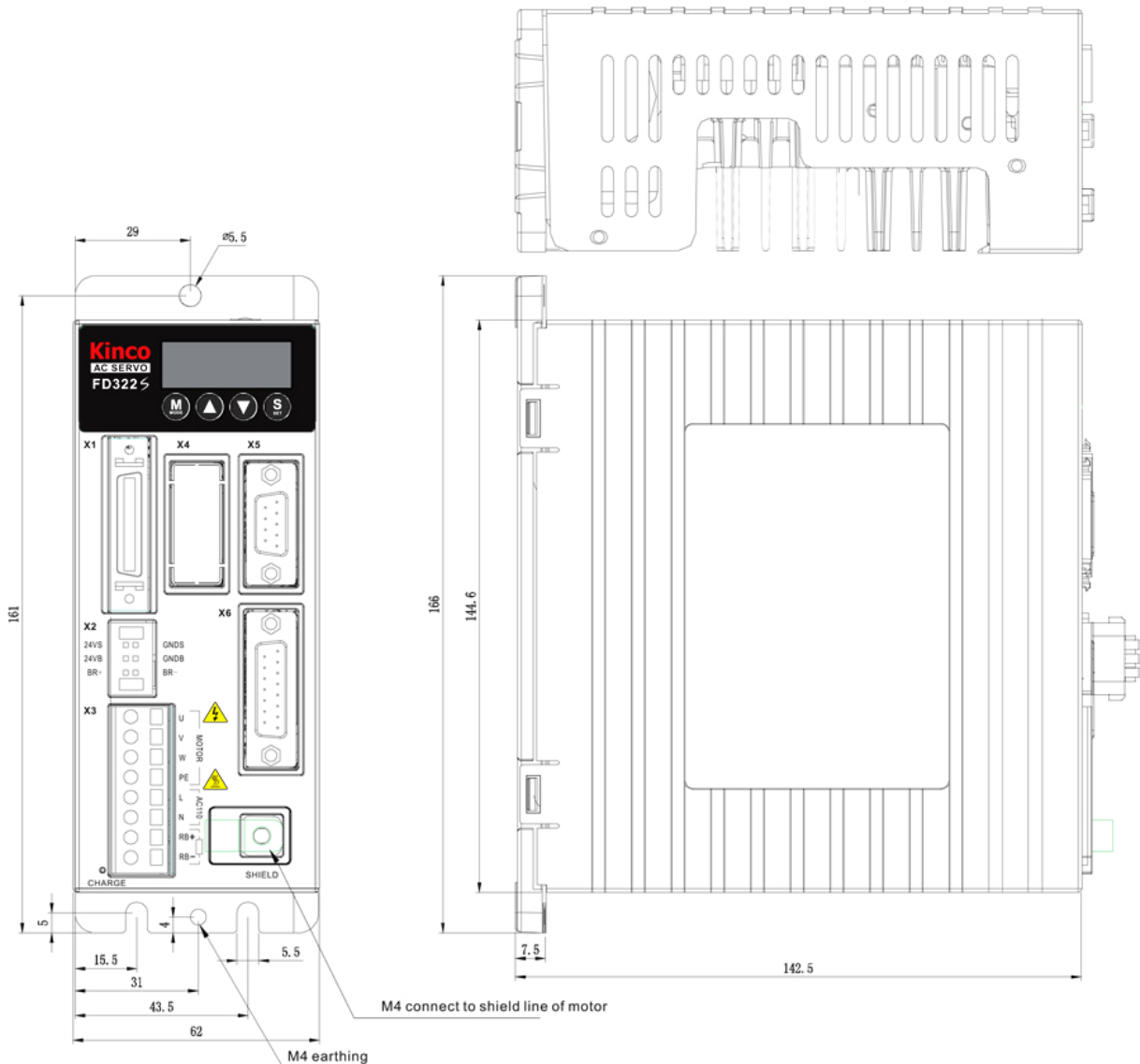

Dimensions are in mm

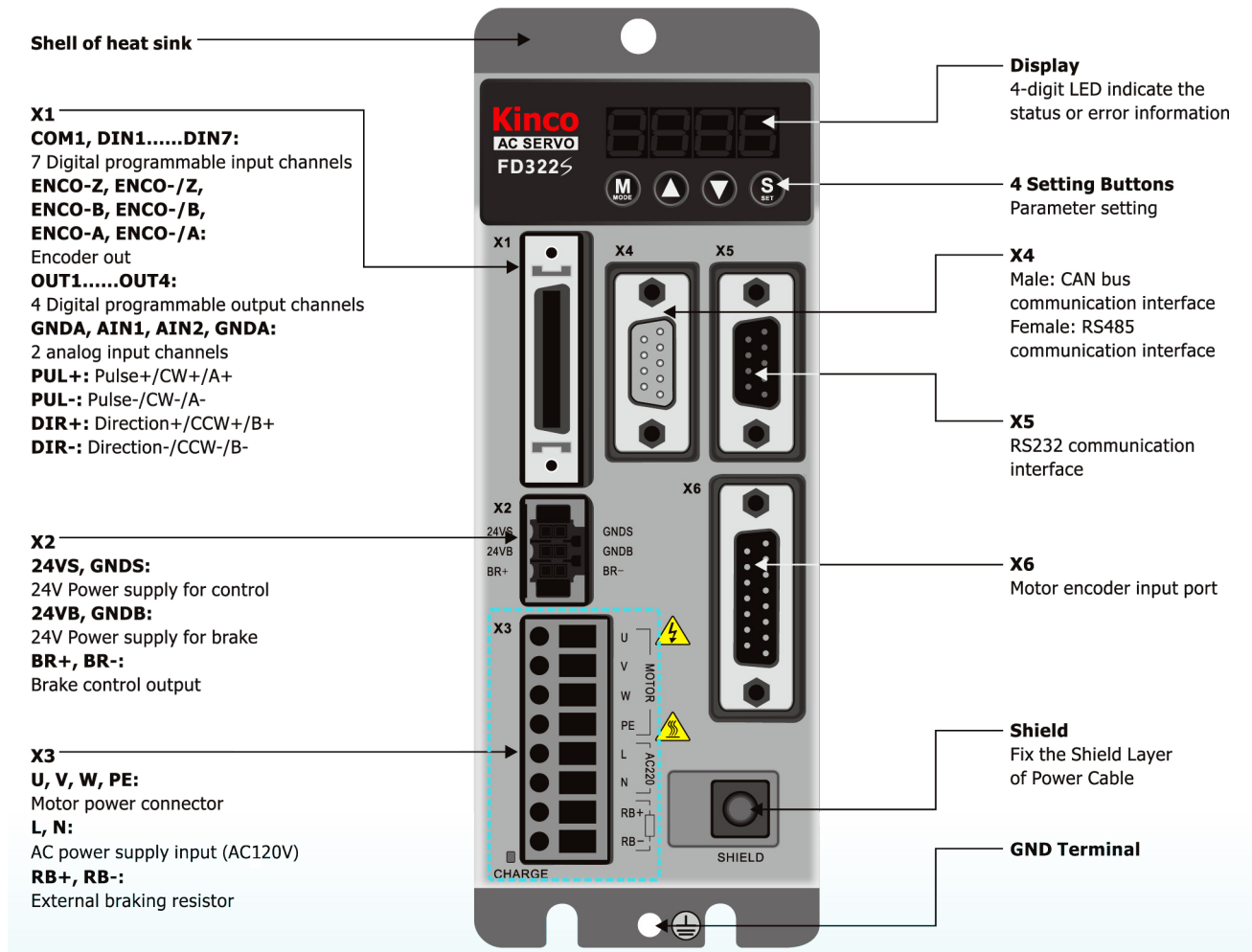

## Digital Input/Output Port

| PIN No. | Signal | PIN No. | Signal | PIN No. | Signal  | PIN No. | Signal |
|---------|--------|---------|--------|---------|---------|---------|--------|
| 2       | COM1   | 1       | OUT1+  | 20      | NC      | 19      | AIN1   |
| 4       | DIN1   | 3       | OUT1-  | 22      | NC      | 21      | GNDA   |
| 6       | DIN2   | 5       | OUT2+  | 24      | GND     | 23      | AIN2   |
| 8       | DIN3   | 7       | OUT2-  | 26      | ENCO-Z  | 25      | GNDA   |
| 10      | DIN4   | 9       | OUT3   | 28      | ENCO-/Z | 27      | PUL+   |
| 12      | DIN5   | 11      | OUT4   | 30      | ENCO-B  | 29      | PUL-   |
| 14      | DIN6   | 13      | COM0   | 32      | ENCO-/B | 31      | DIR+   |
| 16      | DIN7   | 15      | NC     | 34      | ENCO-A  | 33      | DIR-   |
| 18      | NC     | 17      | NC     | 36      | ENCO-/A | 35      | NC     |

X1

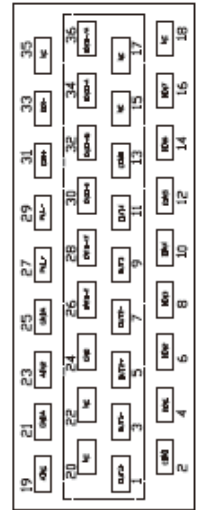

CAN

RS485

| PIN Number | Signal | PIN Number | Signal |
|------------|--------|------------|--------|
| 1          | NC     | 1          | NC     |
| 2          | CAN_L  | 2          | RX+    |
| 3          | GND    | 3          | TX+    |
| 4          | NC     | 4          | NC     |
| 5          | NC     | 5          | GND    |
| 6          | NC     | 6          | +5V    |
| 7          | CAN_H  | 7          | RX-    |
| 8          | NC     | 8          | TX-    |
| 9          | NC     | 9          | NC     |

X4

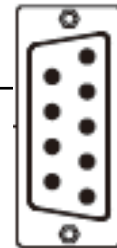

9 pin DB

RS232

| PIN Number | Signal |
|------------|--------|
| 1          | NC     |
| 2          | TX     |
| 3          | RX     |
| 4          | NC     |
| 5          | GND    |
| 6          | NC     |
| 7          | NC     |
| 8          | NC     |
| 9          | NC     |

X5

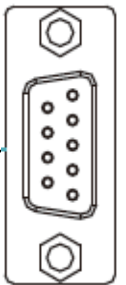

ENCODER IN

| PIN No. | Incremental Encoder Signal | PIN No. | Incremental Encoder Signal | PIN No. | Communication Encoder Signal | PIN No. | Communication Encoder Signal |
|---------|----------------------------|---------|----------------------------|---------|------------------------------|---------|------------------------------|
| 1       | +5V                        | 9       | GND                        | 1       | +5V                          | 9       | GND                          |
| 2       | A                          | 10      | /A                         | 2       | NC                           | 10      | NC                           |
| 3       | B                          | 11      | /B                         | 3       | NC                           | 11      | NC                           |
| 4       | Z                          | 12      | /Z                         | 4       | NC                           | 12      | NC                           |
| 5       | U                          | 13      | /U                         | 5       | NC                           | 13      | NC                           |
| 6       | V                          | 14      | /V                         | 6       | NC                           | 14      | NC                           |
| 7       | W                          | 15      | /W                         | 7       | SD                           | 15      | /SD                          |
| 8       | PTC_IN                     |         |                            | 8       | NC                           |         |                              |

X6

Motor Encoder Input Port

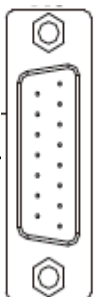

15 Pin DB Female

## Compatible Drivers

| Part Number   | Description  |
|---------------|--------------|
| FD322S-LA-000 | Servo Driver |



## Compatible Motors

| Part Number            | Description |
|------------------------|-------------|
| SMH60S-0020-30AAK-3AKH | Servo Motor |
| SMH60S-0020-30ABK-3AKH | Servo Motor |



## Compatible Cables

| Part Number   | Description   |
|---------------|---------------|
| ENCCA-05-KH   | Encoder Cable |
| MOT-005-05-KL | Power Cable   |
| BRA-05-KL     | Brake Cable   |

